

ORTHOPEDIC RETRACTORS

Orthopedic retractors are designed to provide clear visibility and access to surgical sites by safely holding back tissue and muscle. Our retractors offer strong yet controlled retraction, minimizing trauma and improving efficiency during procedures. Manufactured from high-grade stainless steel, they are available in a variety of styles to suit different anatomical areas and surgical needs.



HAND-HELD ORTHOPEDIC RETRACTORS

FRAZIER HOOKS

5" (12.5 cm).



CODE #	DESCRIPTION
AW48158	1 sharp prong, 2.5 mm diameter
AW48161	1 blunt prong, 2.5 mm diameter

ADSON DIAWECTOR HOOKS

8" (20.5 cm).

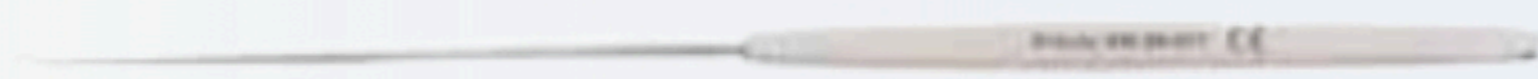

CODE #	DESCRIPTION
654180	Blunt
654181	Sharp

GILLIES HOOKS

7" (18 cm).



CODE #	DESCRIPTION
AW58077	Small
AW58083	Large

FRAZIER DURA HOOKS



CODE #	DESCRIPTION
654190	Blunt, 4-3/4" (12 cm)
654191	Sharp, 4-7/8" (12.5 cm)

HOEN HOOKS

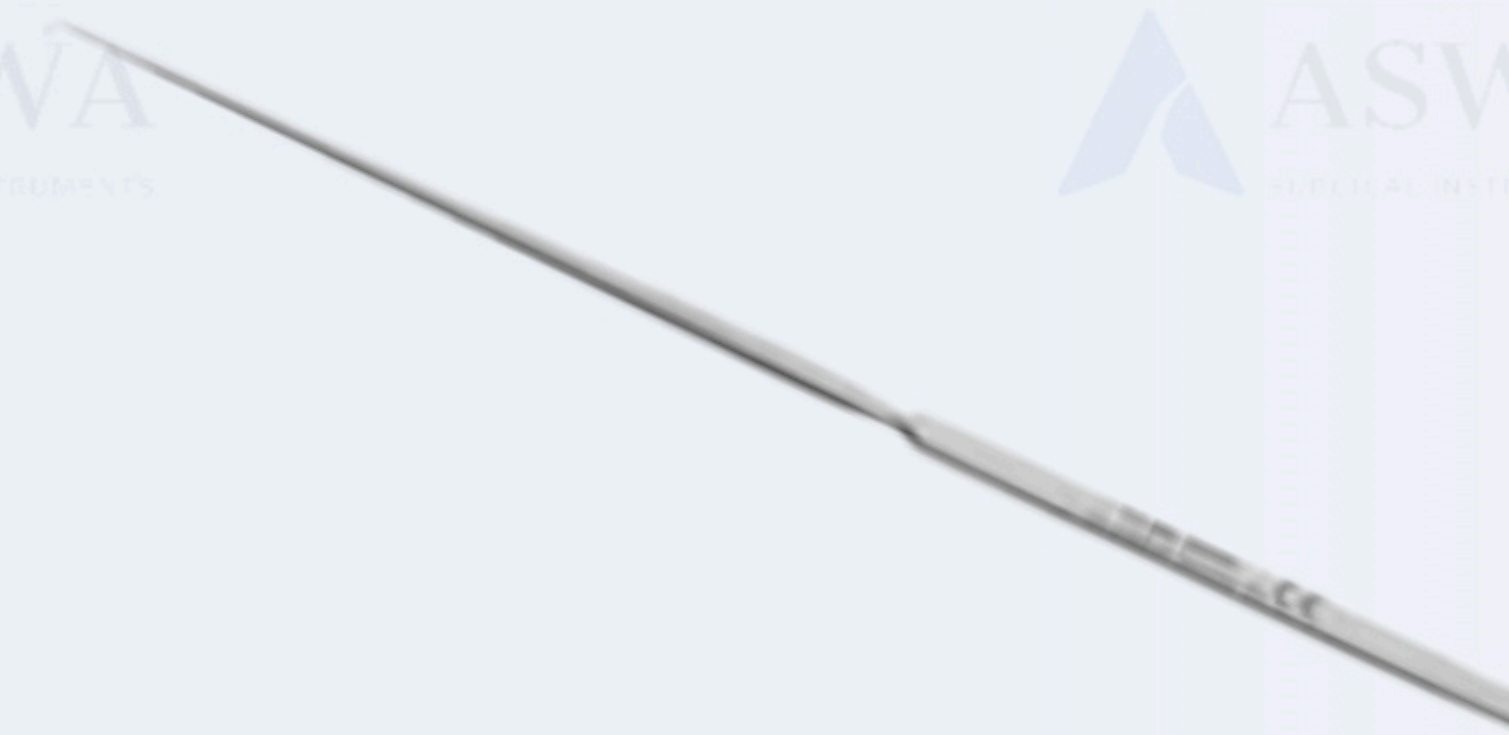

CODE #	DESCRIPTION
594400	Short prong
594402	Long prong

SMITHWICK DIAWECTOR AND HOOK



CODE #	DESCRIPTION
622700	12-1/4" (31 cm)

SNOOK HOOK



CODE #	DESCRIPTION
AW71431	8" (20.5 cm)

HOLSHER NERVE RETRACTORS



CODE #	DESCRIPTION
AW48234	7 mm blade
AW48237	9 mm blade

NERVE ROOT RETRACTOR

Retractor blade lies on same plane as surgeon's finger. Gives surgeon unobstructed view



CODE #	DESCRIPTION
AW55424	6 mm blade, 8-1/4" (21 cm)

SCOVILLE NERVE ROOT RETRACTORS

Angled.



CODE #	DESCRIPTION
AW55426	8 mm blade, 8" (20.5 cm)
AW55428	13 mm blade, 7-5/8" (19.5 cm)

RAGNELL-LINDE RETRACTOR

Fine cross serrations help prevent slippage. Double-ended with serrations, 5-1/4" (13.5 cm).

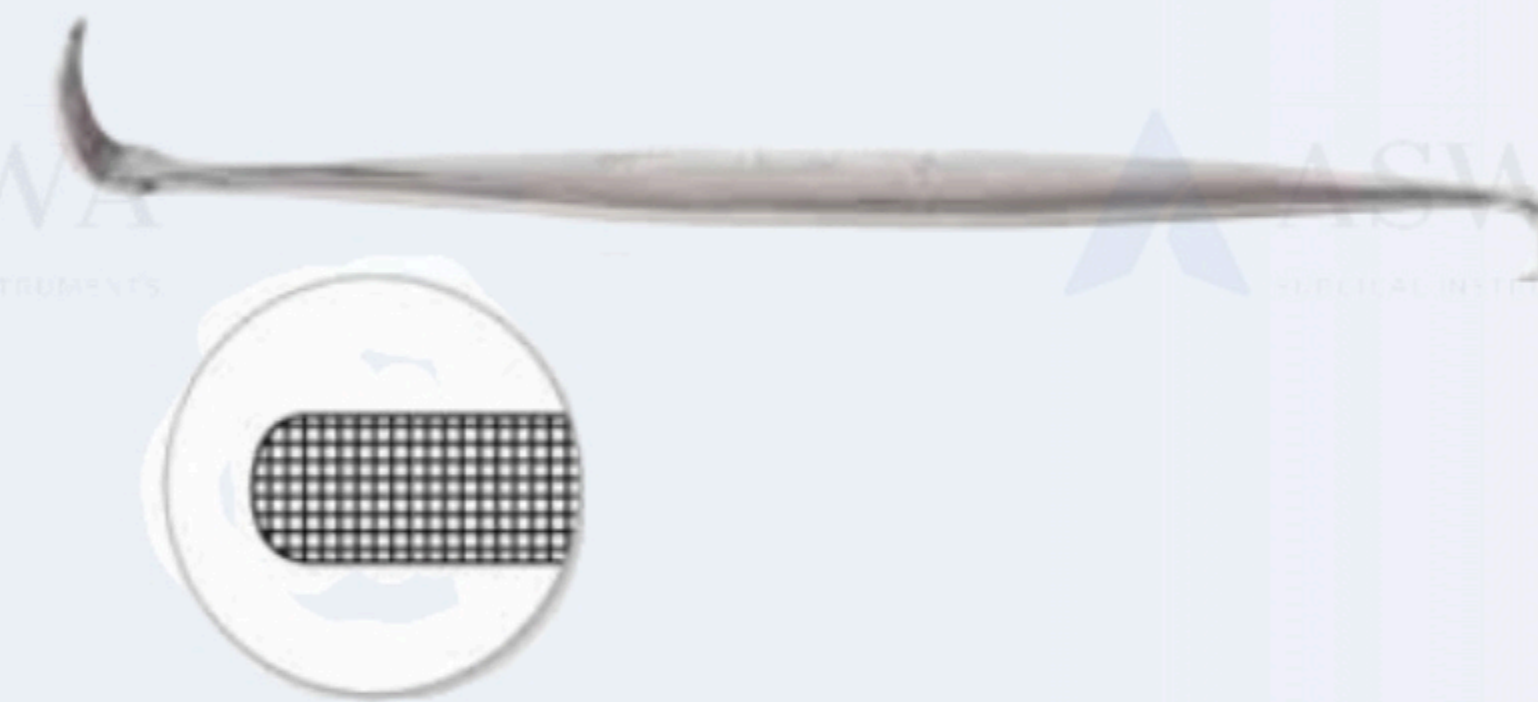

CODE #	DESCRIPTION
AW69982	4 x 8 mm and 6 x 15 mm blades

BAYONET NERVE RETRACTOR

CODE #	DESCRIPTION
AW69982	7 mm wide x 1 mm deep blade

PERPENDICULAR NERVE RETRACTOR

CODE #	DESCRIPTION
AW69982	7 mm wide x 1 mm deep blade angled 90 degrees

BLADE RETRACTORS



CODE #	DESCRIPTION
AW55420	18 mm wide blade, 7" (18 cm)
AW55421	20 mm wide blade, 7" (18 cm)
AW55422	23 mm wide blade, 7" (18 cm)

LANGENBECK RETRACTORS

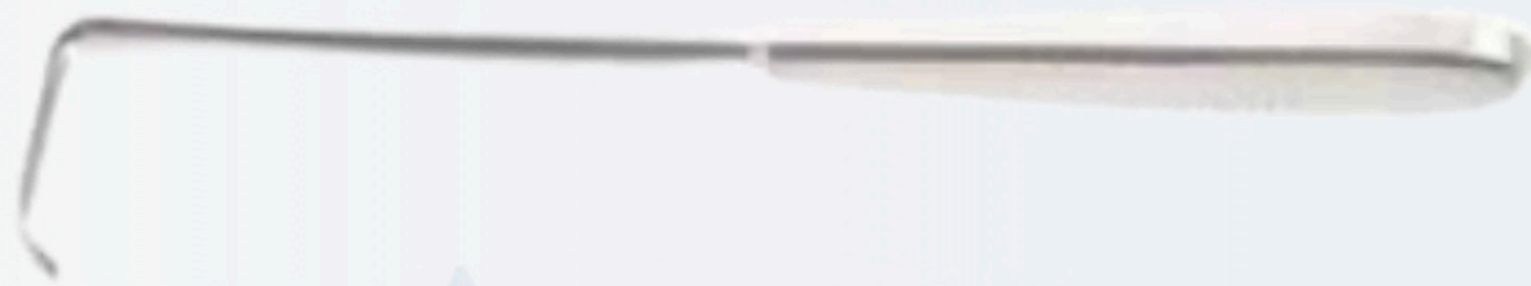

CODE #	DESCRIPTION
AW51100	#1, 3/8" x 1-1/4" (10 x 32 mm), 8-7/8" (22.5 cm)
AW51104	#2, 3/8" x 1-3/4" (10 x 45 mm), 8" (20.5 cm)
AW51108	#3, 1/2" x 1-3/4" (15 x 45 mm), 8-1/2" (21.5 cm)
AW51112	#4, 5/8" x 1-1/2" (16 x 38 mm), 8" (20.5 cm)

OLLIER RAKE RETRACTOR



CODE #	DESCRIPTION
AW52282	4 blunt prongs, 55 mm wide x 40 mm deep blade, 9" (23 cm)

DEEP RAKE RETRACTORS

10-1/2" (26.5 cm).



CODE #	DESCRIPTION
AW52292	4 blunt prongs, 2-1/4" wide x 1-1/2" deep (5.5 x 4 cm)
AW52294	4 blunt prongs, 2-1/4" wide x 2" deep (5.5 x 5 cm)
AW52296	4 blunt prongs, 2-1/4" wide x 2-1/2" deep (5.5 x 6.5 cm)
AW52298	4 blunt prongs, 2-1/4" wide x 3" deep (5.5 x 7.5 cm)

MEYERDING LAMINECTOMY RETRACTORS

Sharp teeth.



CODE #	DESCRIPTION
AW51158	Small, 17 mm wide blade, 9-1/2" (24 cm)
AW51162	Medium, 25 mm wide blade, 9-1/2" (24 cm)
AW51164	Large, 50 mm wide blade, 10" (25.5 cm)

ISRAEL RAKE RETRACTORS

9-1/2" (24 cm)



CODE #	DESCRIPTION
AW51078	3 blunt prongs, 30 mm wide x 37 mm deep
AW51080	4 blunt prongs, 40 mm wide x 40 mm deep

HIBBS RETRACTORS

Used for deep soft tissue retraction. Sharp teeth, 9-1/2" (24 cm)

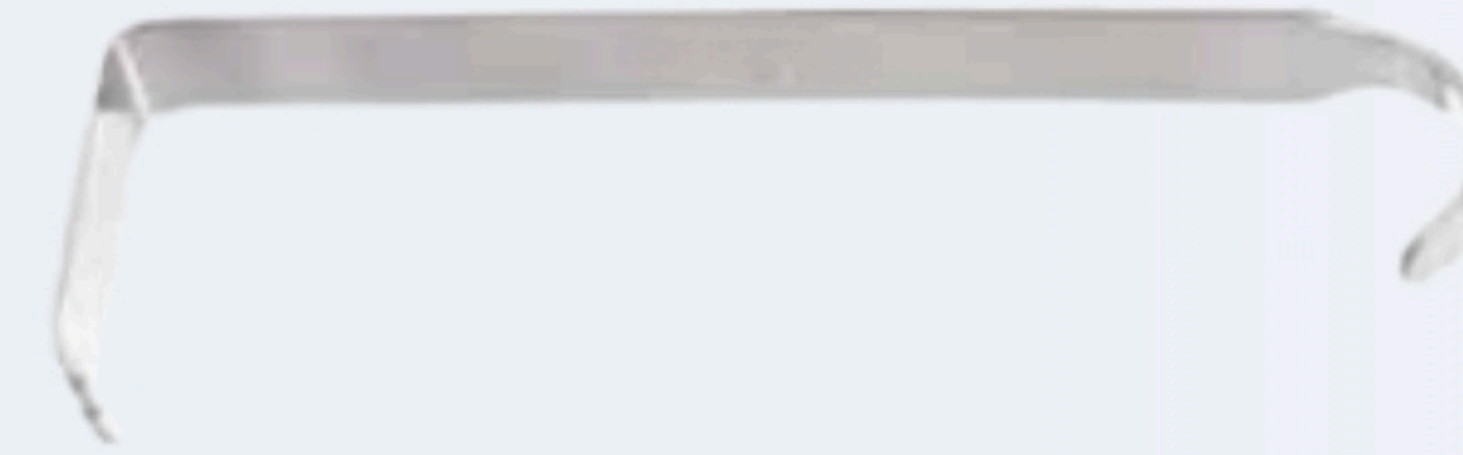

CODE #	DESCRIPTION
AW51059	25 mm wide x 50 mm deep blade
AW51060	26 mm wide x 75 mm deep blade
AW51061	25 mm wide x 100 mm deep blade

TAYLOR SPINAL RETRACTORS



CODE #	DESCRIPTION
AW52458	1-1/4" wide x 3" long blade (3 x 7.5 cm), 7-3/4" (19.5 cm)
AW52460	1-1/4" wide x 4" long blade (3 x 10 cm), 7-3/4" (19.5 cm)

AUFRANC COBRA RETRACTORS

With hollow handle, 1-1/4" wide blade, 10-1/2" (26.5 cm)

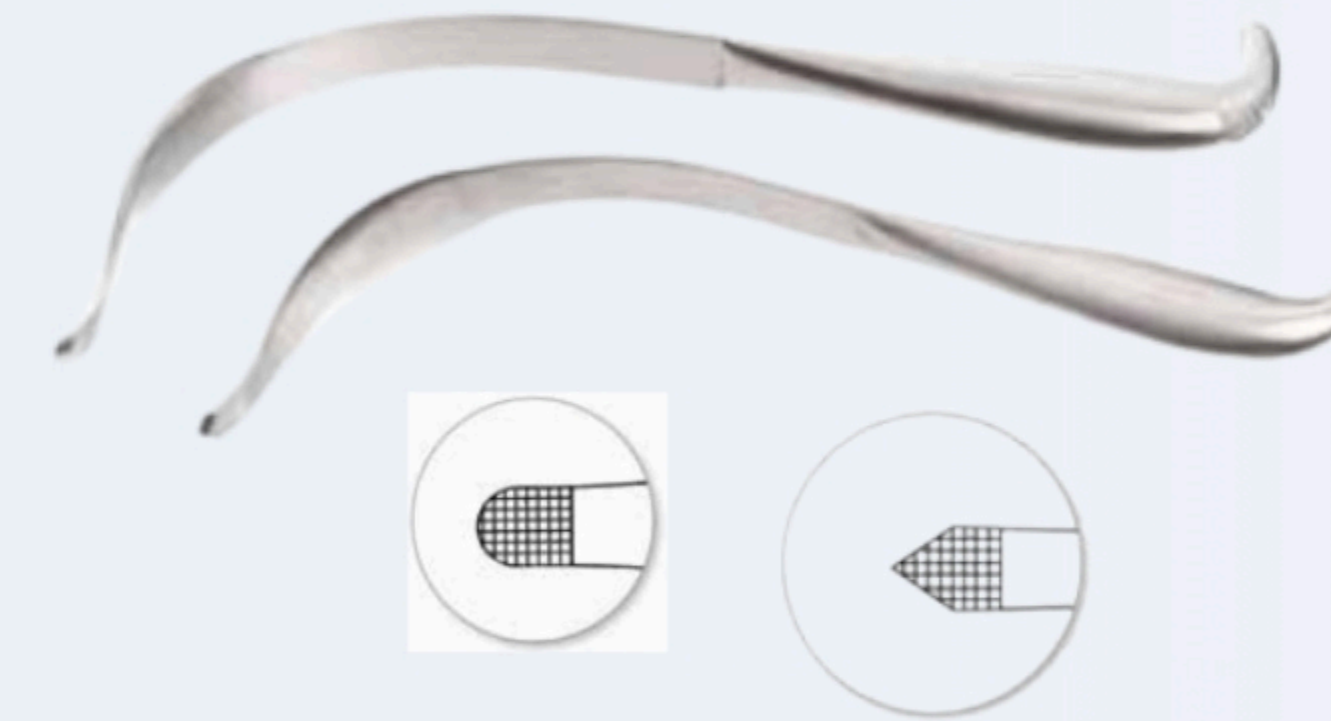

CODE #	DESCRIPTION
AW48208	Serrated, pointed tip, 10 mm
AW48212	Smooth, blunt tip, 10 mm
AW48210	Serrated, blunt tip, 10 mm
AW48214	Smooth, pointed tip, 10 mm

TAYLOR RETRACTORS



CODE #	DESCRIPTION
AW46934	Distal tip 3/4" wide and 3" long (20 x 76 mm), overall length 8-1/8" (20.5 cm)
AW46936	Distal tip 3/4" wide and 4" long (20 x 102 mm), overall length 8-1/8" (20.5 cm)

BENNETT BONE ELEVATOR AND RETRACTORS

Hollow handle, 10" (25.5 cm).



CODE #	DESCRIPTION
AW46880	Small, 1-3/4" (4.5 cm) wide blade
AW46884	Large, 2-1/2" wide blade

MURPHY BONE SKID



CODE #	DESCRIPTION
AW46892	11-3/4" (30 cm)

PELVIC RETRACTOR



CODE #	DESCRIPTION
AW48201	1" (24 mm) wide blade, 1/2" (12 mm) wide distal tip, 10-5/8" (27 cm)

SHOULDER & KNEE RETRACTORS

FUKUDA STYLE SHOULDER RETRACTORS

7" (18 cm).



CODE #	DESCRIPTION
AW46906	1-1/2" wide x 3-1/4" long blade (4 x 8 cm)
AW46907	1-1/4" wide x 3-1/4" long blade (3 x 8 cm)

BRISTOW/BANKART HUMERAL RETRACTOR

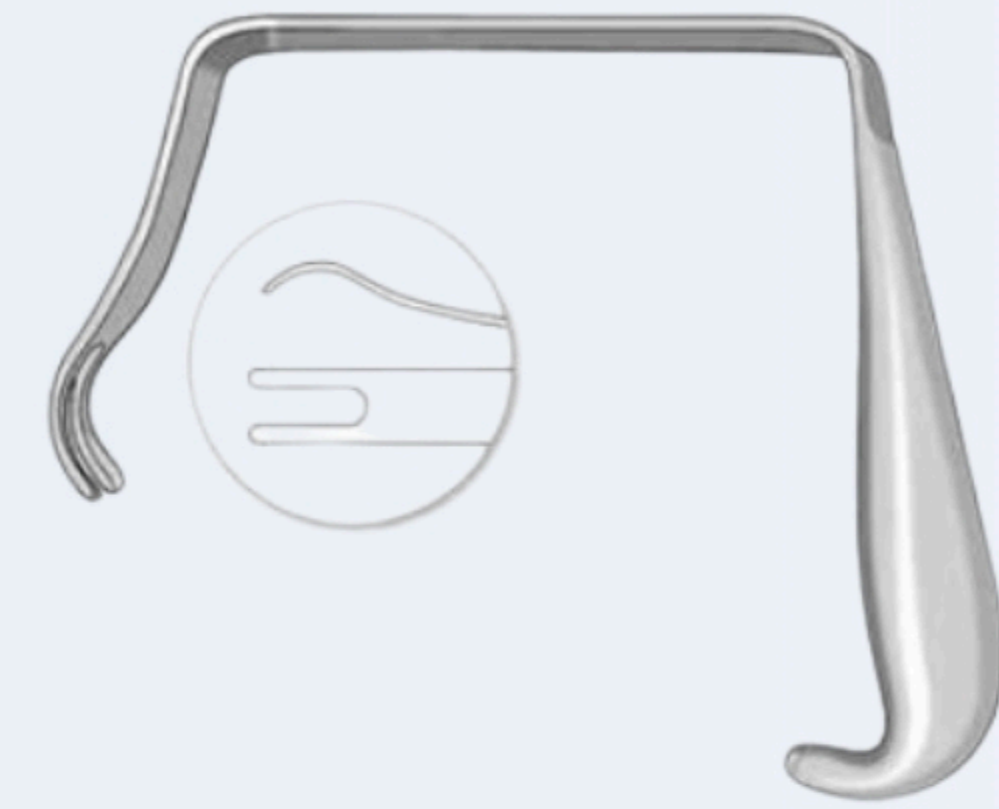

CODE #	DESCRIPTION
AW46870	2 blunt prongs, 25 mm wide x 102 mm deep, 7-1/2" (19 cm)

BRISTOW/BANKART SOFT TIAWUE RETRACTOR



CODE #	DESCRIPTION
AW46872 3	3 blunt prongs, 21 mm wide blade, 7-7/8" (20 cm)

HUMERAL HEAD RETRACTOR



CODE #	DESCRIPTION
AW46860	18 mm wide blade, 8-3/4" (22 cm)

CAPSULE RETRACTOR



CODE #	DESCRIPTION
AW46908	3 blunt prongs, 21 mm wide blade, 7-7/8" (20 cm)

BLOUNT DOUBLE PRONG RETRACTOR



CODE #	DESCRIPTION
AW48204	1-3/4" (44 mm) wide blade, 10-1/2" (26.5 cm)

BLOUNT KNEE RETRACTOR



CODE #	DESCRIPTION
AW48206	6 mm wide distal tip, 6-7/8" (17.5 cm)

BLOUNT SINGLE PRONG RETRACTOR



CODE #	DESCRIPTION
AW48202	1-1/2" (37 mm) width blade, 10-1/2" (26.5 cm)

SMILLIE KNEE RETRACTORS

5-1/2" (14 cm).



CODE #	DESCRIPTION
AW48192	Reverse curve, 13 mm wide x 55 mm long blade
AW48198	19 mm wide x 30 mm long blade
AW48194	19 mm wide x 45 mm long blade
AW48196	19 mm wide x 60 mm long blade
AW48200	Full curve, 13 mm wide x 18 mm long blade

HOHMANN RETRACTORS

HAYES HAND RETRACTORS

Used to elevate carpals and phalanges during hand procedures.



CODE #	DESCRIPTION
AW46823	3 mm wide distal tip, 6-1/4" (16 cm)
AW46829	6 mm wide distal tip, 6" (15 cm)

HOHMANN RETRACTORS



CODE #	DESCRIPTION
AW46858	8 mm wide blade, 8-1/2" (21.5 cm)
AW46836	10 mm wide blade, 9" (23 cm)
AW46838	18 mm wide blade, 9" (23 cm)
AW46848	22 mm wide blade, three holes, 11" (28 cm)

MINI HOHMANN RETRACTORS

6-1/2" (16.5 cm).

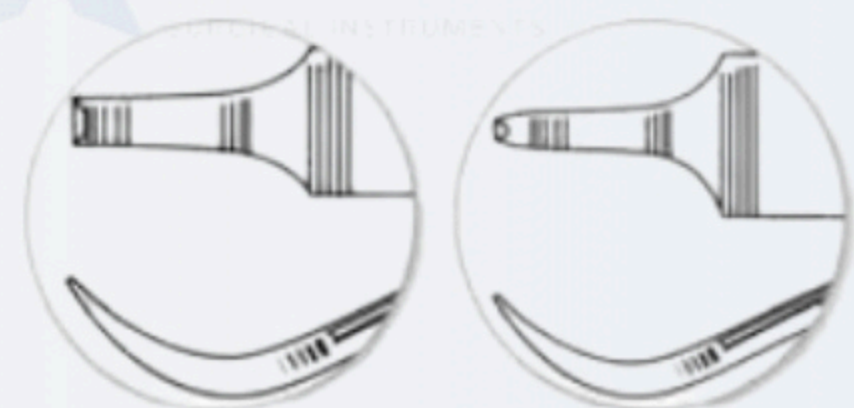

CODE #	DESCRIPTION
AW46830	6 mm wide blade
AW46832	8 mm wide blade

HOHMANN RETRACTORS



CODE #	DESCRIPTION
AW46842	43 mm wide blade, 9-1/2" (24 cm)
AW46841	43 mm wide blade, long 64 mm shank, 9" (23 cm)
AW46850	70 mm wide blade, 9-1/2" (24 cm)

HOHMANN RETRACTORS

For small fragments



CODE #	DESCRIPTION
AW46826	Finger ring handle, broad tip, 16 mm wide blade, 4-3/4" (12 cm)

HOHMANN RETRACTORS

Useful in exposing acetabulum

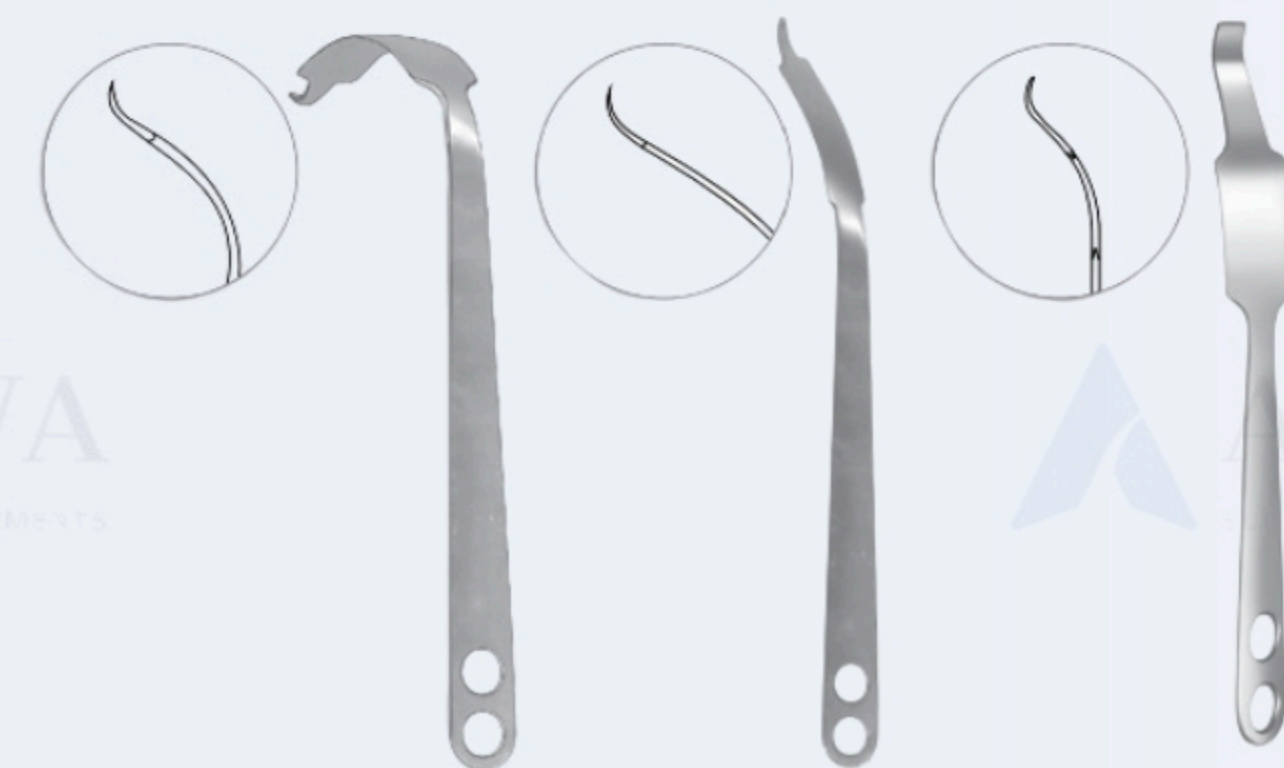

CODE #	DESCRIPTION
AW46849	35 mm wide blade with wide tip, long 52 mm shank, 11-1/4" (28.5 cm)
AW46852	22 mm wide blade curved 120 degrees, 16" (40.5 cm)
AW46854	40 mm wide blade curved 90 degrees, 13" (33 cm)

HOHMANN RETRACTORS



CODE #	DESCRIPTION
AW46827	Broad tip, 15 mm wide blade, 6" (15 cm)



VICKERS FINGER RETRACTOR

The new Vickers Retractors are designed to provide excellent visibility during hand and wrist procedures. Each of the retractors is self-retaining and automatically expands the wound site. Ideal for retracting wounds on either the front, back or sides of fingers or thumb



CODE #	DESCRIPTION
AW52425	VICKERS FINGER RETRACTOR AW52425 2" x 3/4" x 1-1/4" (51 mm x 19 mm x 32 mm) 2 x 2 blunt hooks Maximum opening: 19 mm

VICKERS LOW PROFILE HAND RETRACTOR

With three blunt prongs to secure placement

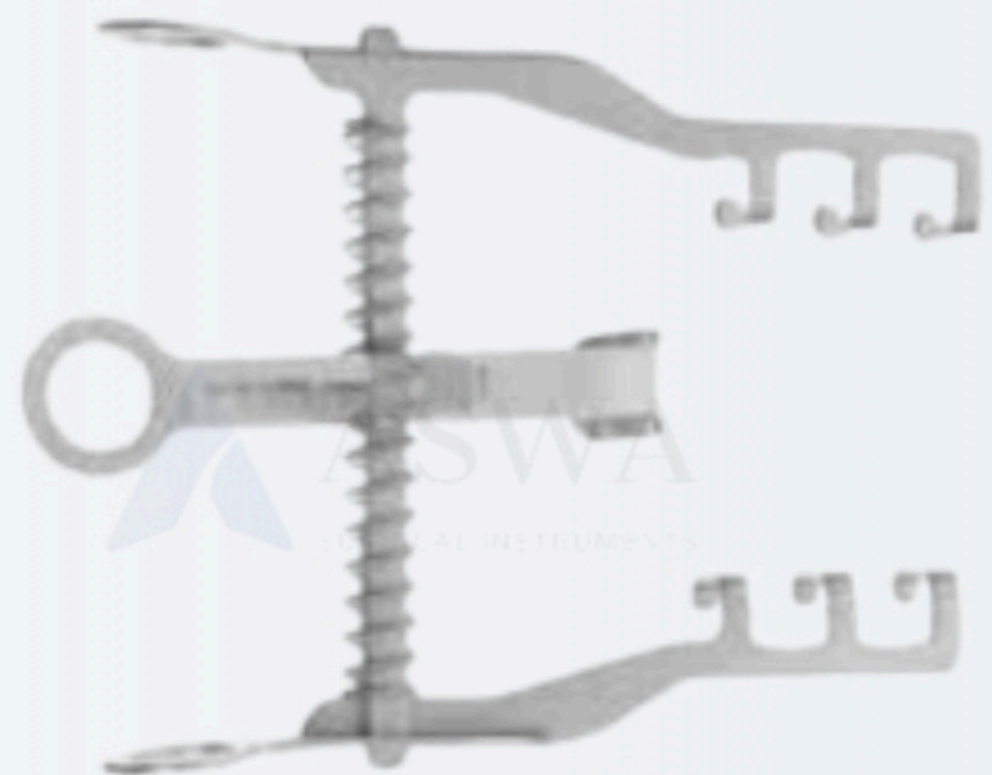

CODE #	DESCRIPTION
AW52427	3 x 3 prongs, 3-1/4" (8.5 cm)

SELF-RETAINING ORTHOPEDIC RETRACTORS

VICKERS LOW PROFILE SMALL WOUND RETRACTOR

Useful for small wound retraction.

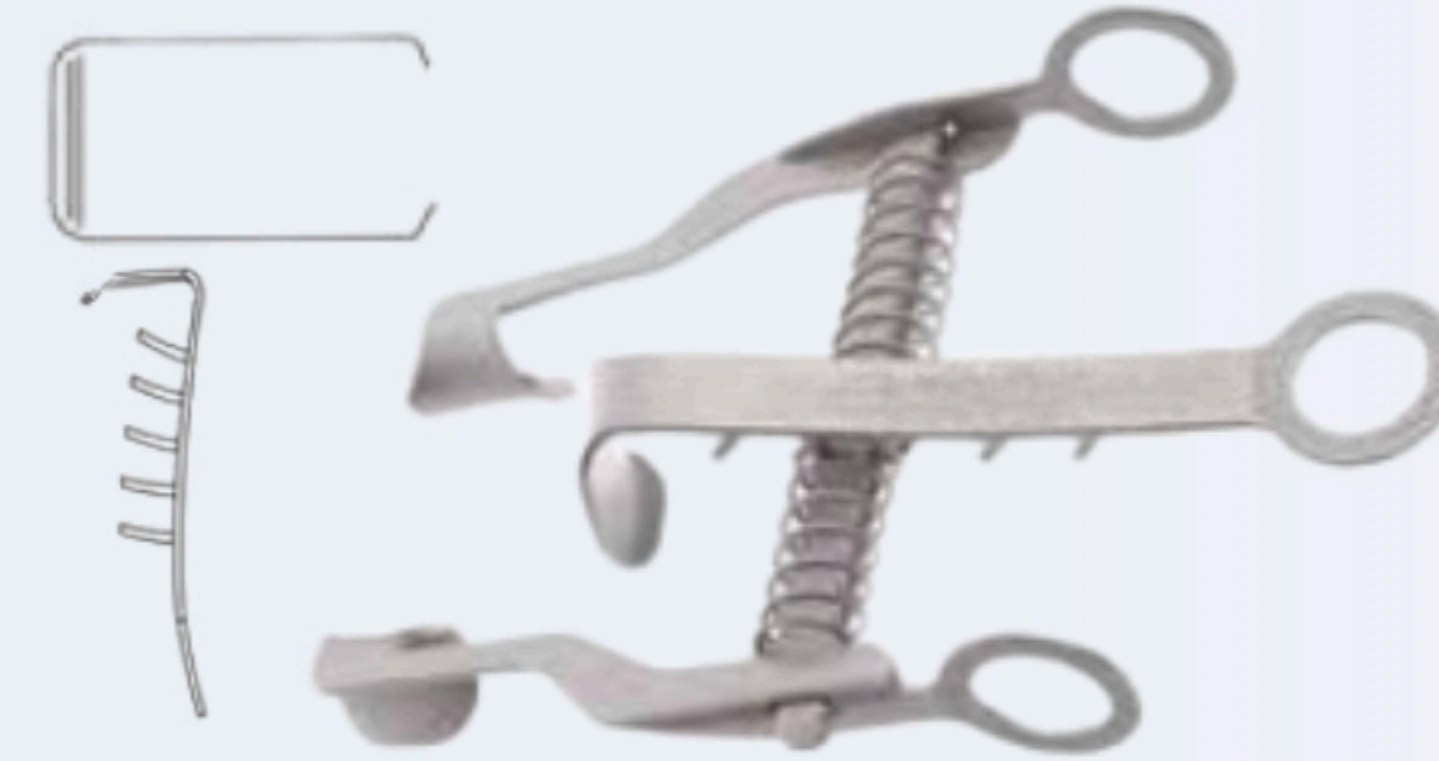

CODE #	DESCRIPTION
AW52426	10 mm deep x 12 mm high, curved, smooth blades, maximum opening 30 mm, center blade 10 mm x 16 mm, 2-1/2" x 3" (6.5 x 7.5 cm)

VICKERS UNIVERSAL RETRACTOR

With two blunt prongs to secure placement

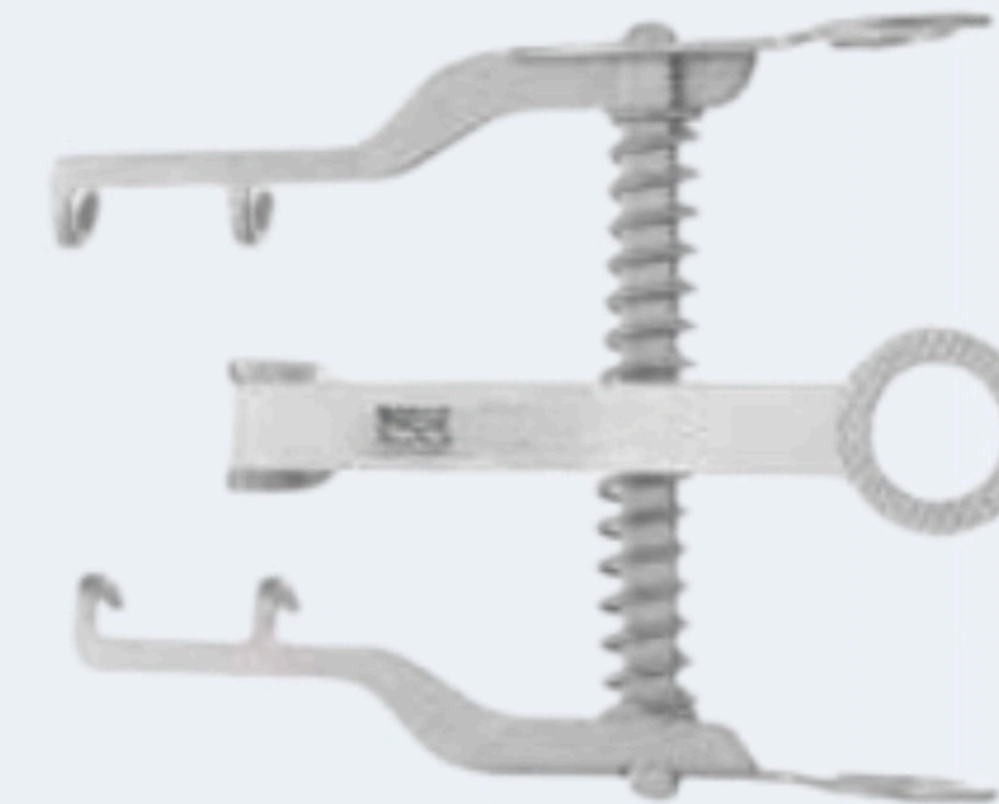

CODE #	DESCRIPTION
AW52428	2 x 2 blunt prongs, 8 mm deep x 17 mm high, maximum opening 30 mm, center blade 10 mm x 16 mm, 2-1/2" x 3" (64 x 75 mm)

COX METATARSAL SPREADER

- Specially designed thin serrated blades fit anatomically correct against the metatarsals.
- Precise design assures slip-proof hold on metatarsals.
- Affords excellent visibility for the surgeon.
- Designed by Dr. Kenneth Cox



CODE #	DESCRIPTION
AW69990	11 mm wide blades, 4-1/2" (11.5 cm)

SNITMAN ENDAURAL RETRACTOR



CODE #	DESCRIPTION
AW55497	3 x 3 sharp prongs

MALTZ-SEEBURGER RETRACTORS



CODE #	DESCRIPTION
AW58240	4-1/2" (11.5 cm)
AW58242	5-1/2" (14 cm)

TIAWUE RETRACTOR

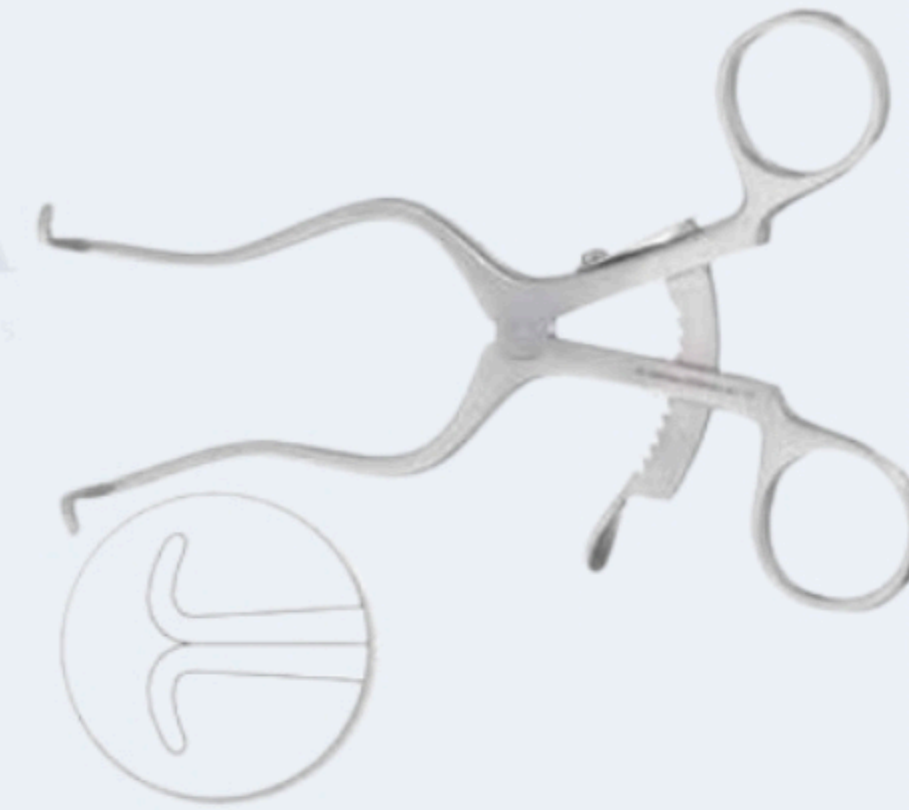

CODE #	DESCRIPTION
AW55438	1 x 1 blunt prongs, 13 mm deep, 5-1/4" (13.5 cm)

KOLBEL SOFT TIAWUE RETRACTOR



CODE #	DESCRIPTION
AW46922	Angled, 2 x 2-pronged, 7" (18 cm)

D'ERRICO-ADSON RETRACTOR

Angular prongs are heavier than those on a standard Adson.

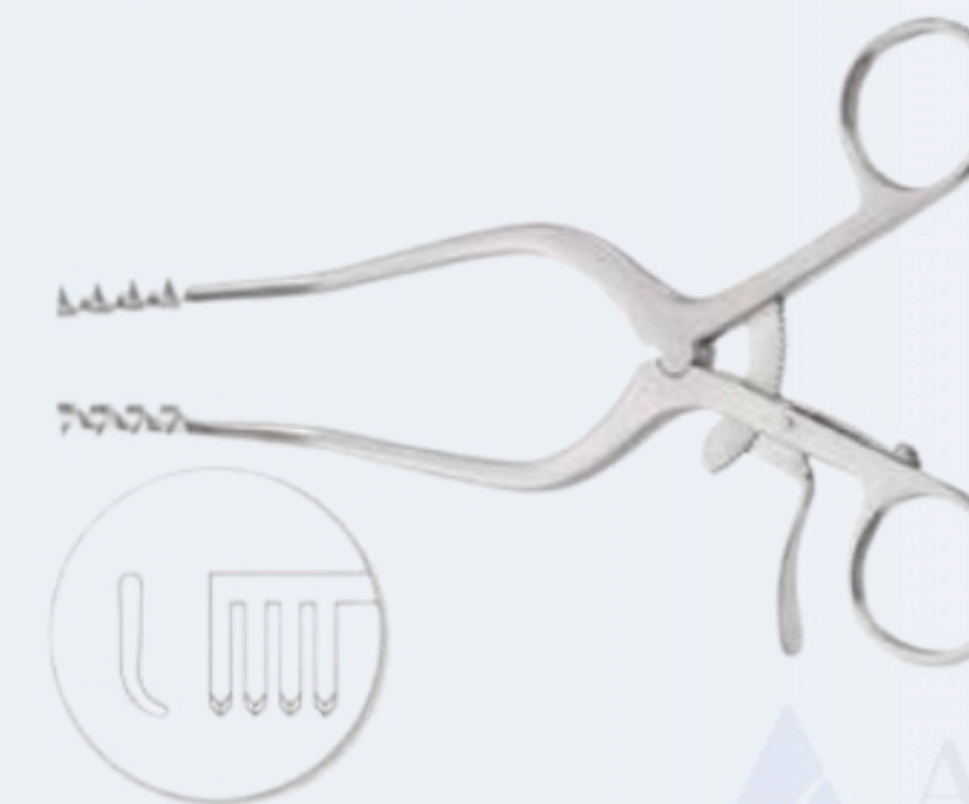

CODE #	DESCRIPTION
AW55498	4 x 4 sharp prongs, 3/4" (2 cm) deep blade, 7-3/8" (19 cm)

SCALP CONTOUR RETRACTORS

Useful in hand procedures because handle is non-obstructive.



CODE #	DESCRIPTION
AW52546	3 x 4 blunt prongs, 5-1/2" (14 cm)
AW52548	3 x 4 sharp prongs, 5-1/2" (14 cm)

MEYERDING LAMINECTOMY RETRACTORS

Sharp blades, 6-1/2" (16.5 cm).



CODE #	DESCRIPTION
AW55430	Blades 57 mm deep x 25 mm wide
AW55431	Blades 51 mm deep x 25 mm wide
AW55432	Blades 41 mm deep x 25 mm wide

GELPI-SELETZ RETRACTOR

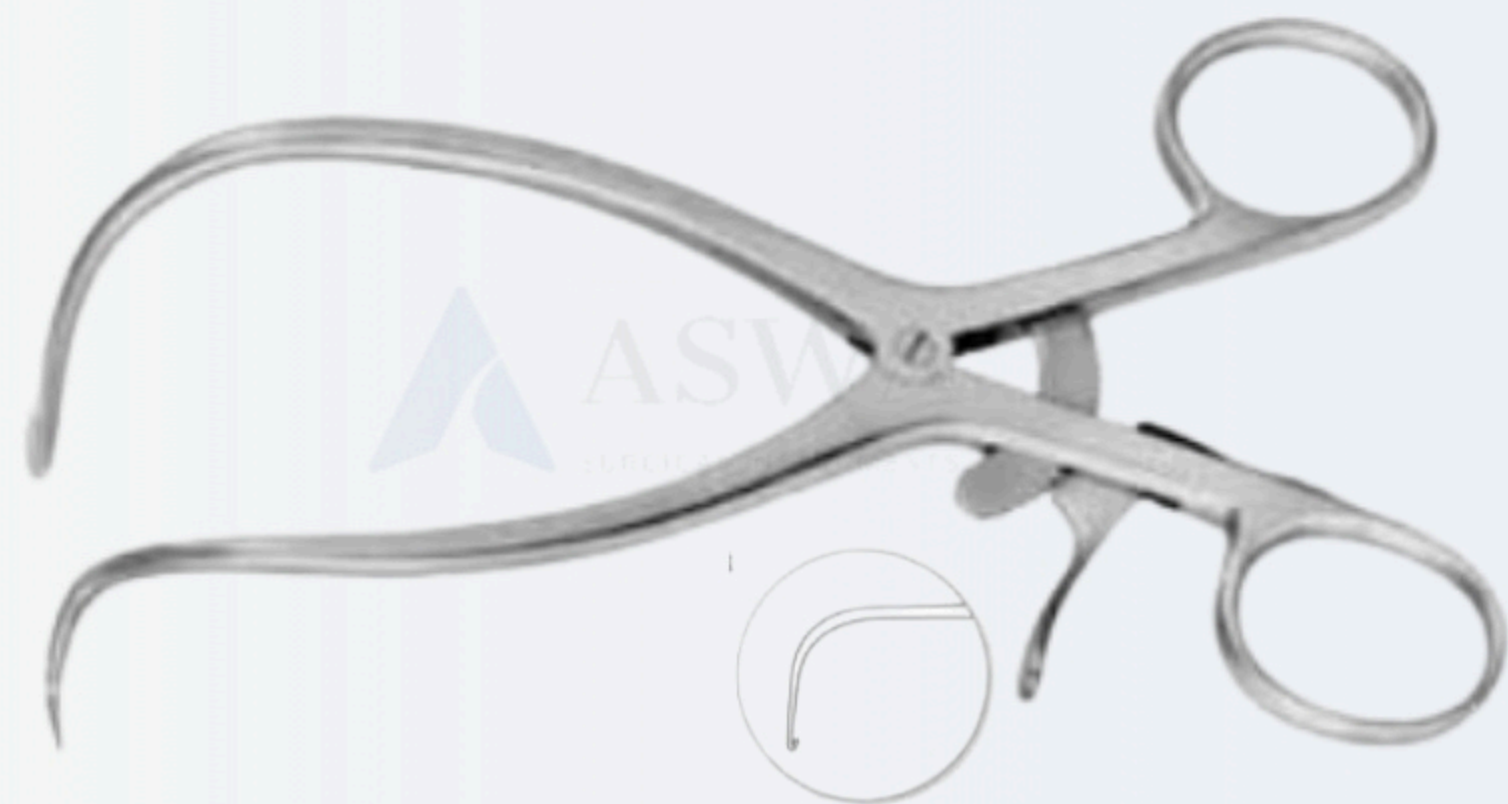

CODE #	DESCRIPTION
AW52765	Sharp points, deep blades, 6-1/4" (16 cm)

MARKHAM-MEYERDING HEMILAMINECTOMY RETRACTORS



CODE #	DESCRIPTION
AW55440	Left sharp blade 60 mm deep x 25 mm wide, 7" (18 cm)
AW55441	Right sharp blade 60 mm deep x 25 mm wide, 7" (18 cm)

WILTSE-GELPI RETRACTOR

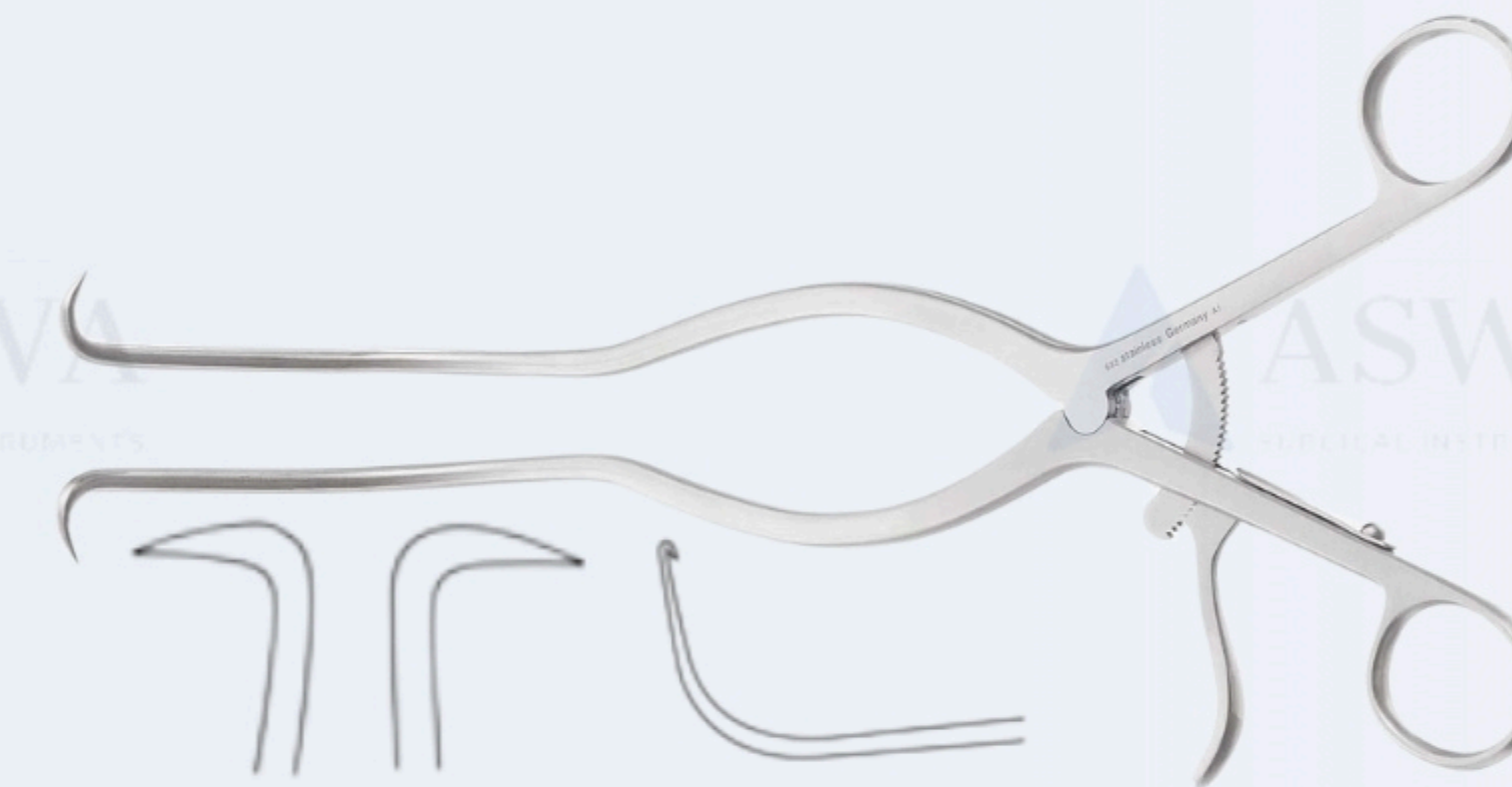

CODE #	DESCRIPTION
AW52771	Deep blades, sharp points, 10-7/8" (27.5 cm)

BECAWAN RETRACTOR



CODE #	DESCRIPTION
AW52470	4 x 4 sharp prongs, 27 mm, side blade 5/8" (1.5 cm) deep, 12-1/4" (31 cm)
AW52472	4 x 4 blunt prongs, 27 mm, side blade 5/8" (1.5 cm) deep, 12-1/4" (31 cm)

CERVICAL RETRACTOR SET

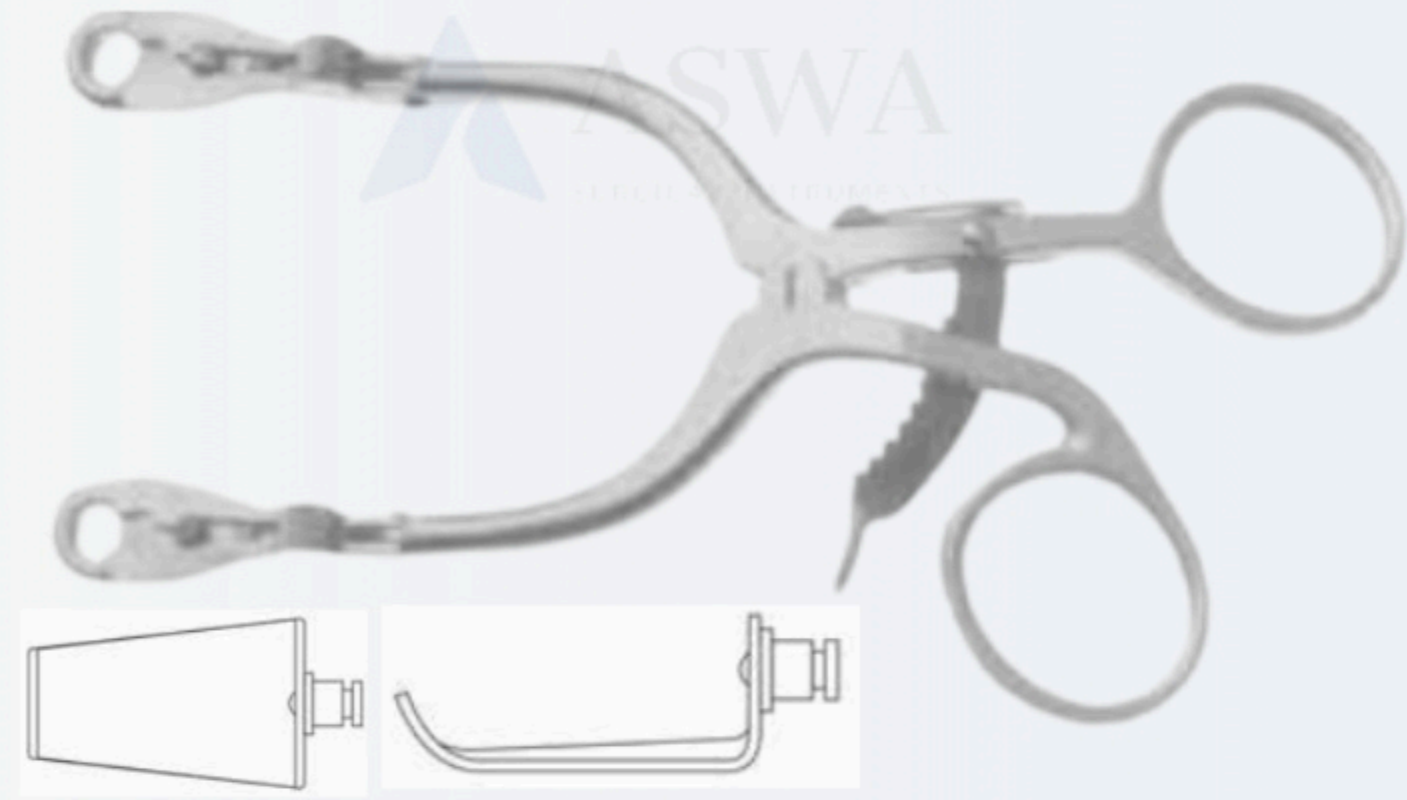

CODE #	DESCRIPTION
AW55481	Cervical retractor body, small, 6" (15 cm)
AW55482	25 mm deep blade, blunt
AW55483	30 mm deep blade, blunt
AW55484	35 mm deep blade, blunt
AW55485	40 mm deep blade, blunt
AW55486	45 mm deep blade, blunt
AW55487	50 mm deep blade, blunt
AW55488	55 mm deep blade, blunt

BECAWAN-EATON RETRACTOR



CODE #	DESCRIPTION
AW52476	7 x 7 sharp prongs, 40 x 48 mm, 12-1/4" (31 cm)

ADSON RETRACTOR

Hinged arm design.



CODE #	DESCRIPTION
AW52474	4 x 5 blunt prongs, 13" (33 cm)

BECAWAN-ADSON LAMINECTOMY RETRACTORS

4 x 4 prongs, hinged blades 25 mm high, 12-1/4" (31 cm).



CODE #	DESCRIPTION
AW52484	Blunt, 25 mm deep
AW52488	Blunt, 44 mm deep, max. opening 6"
AW52486	Sharp, 44 mm deep
AW52490	Sharp, 25 mm deep, max. opening 5-11/16"

VERTEBRA SPREADER (CLOWARD)



CODE #	DESCRIPTION
AW55490	#1 with ratchet, 3/4" (19 mm) spread, 5" (12.5 cm)

BECAWAN-WEITLANER RETRACTORS

With hinged blades. Satin finish, 9-1/2" (24 cm).



CODE #	DESCRIPTION
AW52542	3 x 4 sharp prongs, 22 mm
AW52544	3 x 4 blunt prongs, 22 mm

VERTEBRAL BODY DISTRACTORS



CODE #	DESCRIPTION
AW55410	Small
AW55412	Large, 11 mm wide x 3.8 mm deep jaws, 11-1/4" (28.5 cm)

HORIZONTAL RETRACTOR

Primarily used to retract detached trochanter from the stump of the femoral neck. Hinged arms allow handles to be angled away from surgical site to minimize interference.



CODE #	DESCRIPTION
AW52602	Hinged blades, 4 x 2 sharp prongs, 12-1/4" (31 cm)

SAXENA BONE GRAFTING RETRACTOR

- Ratchet is calibrated in millimeters to accurately assess how wide the lateral portion of the bone graft needs to be.
- Helpful in many types of procedures to accurately assess the amount of bone graft needed, such as for fusions and nonunions.

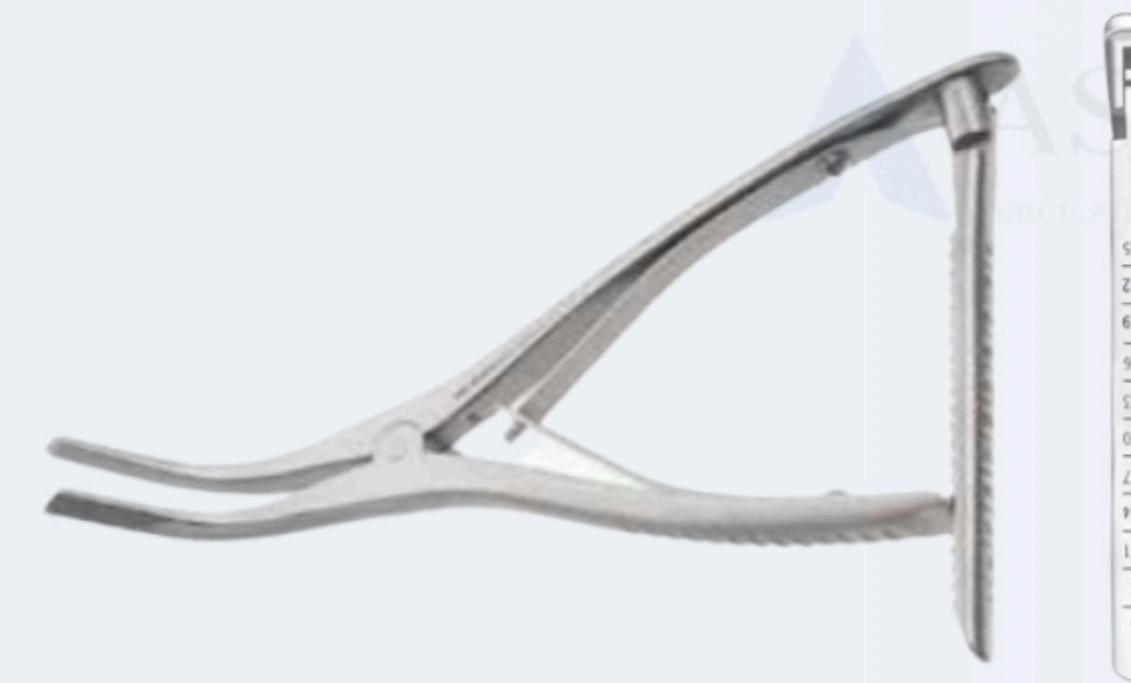

CODE #	DESCRIPTION
AW48220	35 mm graduated ratchet, 6-1/2" (16.5 cm)

LUMBAR LAMINA SPREADERS



CODE #	DESCRIPTION
AW55495	#1, arm length, 3-1/2" (9 cm), 5-1/4" (13.5 cm)
AW55496	#2, arm length, 4-1/4" (11 cm), 5-1/4" (13.5 cm)

INGE RETRACTOR

Available with or without teeth.

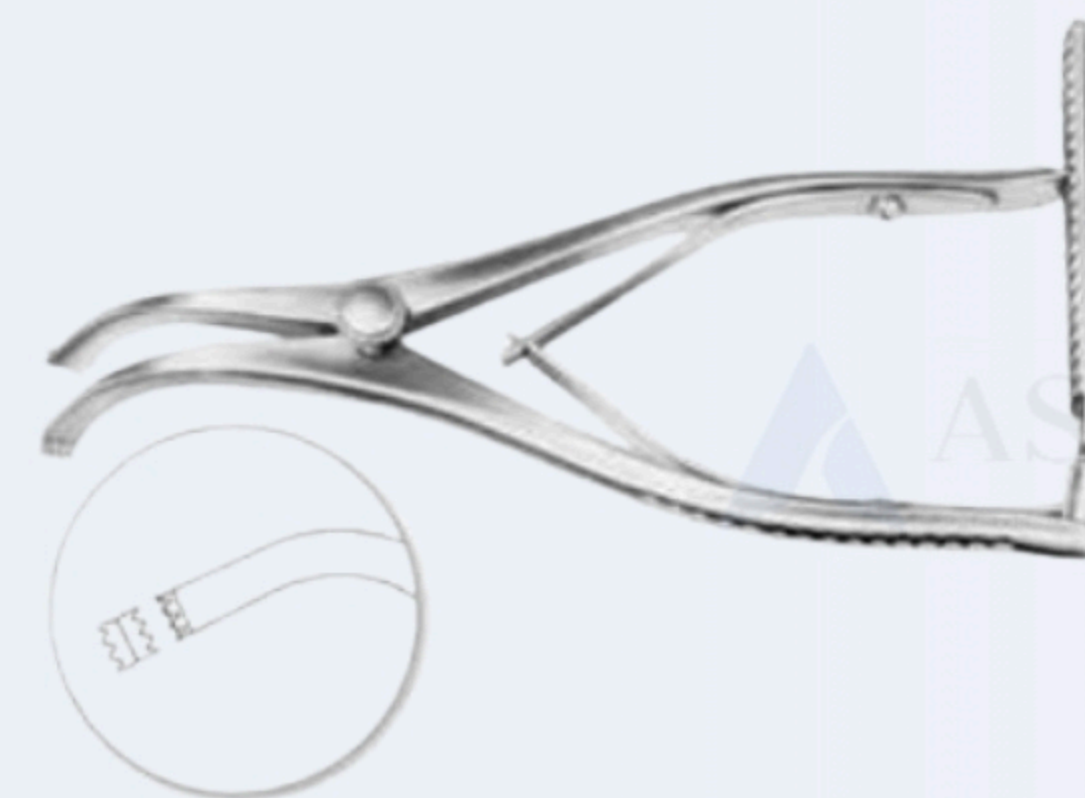

CODE #	DESCRIPTION
AW48217	With teeth, 6-1/2" (16.5 cm)
AW48218	Without teeth, 6-1/2" (16.5 cm)
AW48230	With teeth, 10-3/8" (26.5 cm)

LAMINA SPREADERS

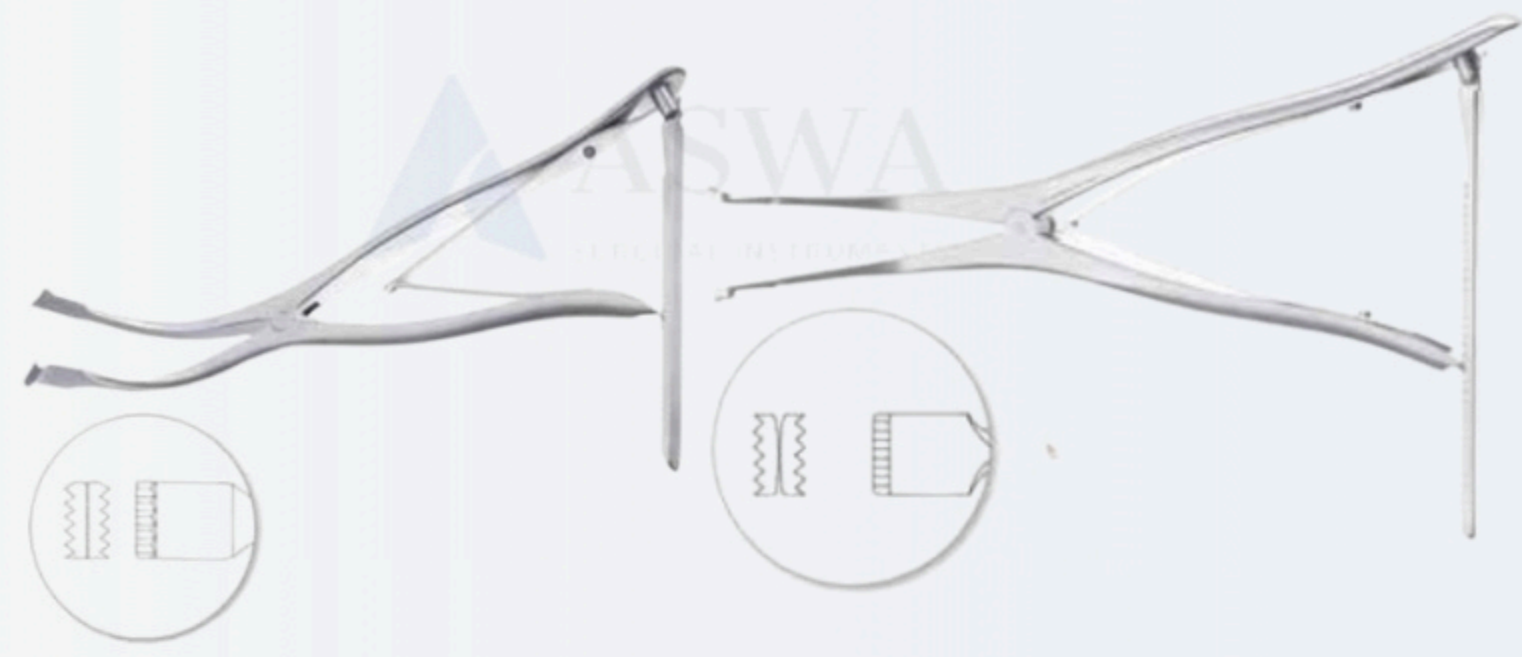

CODE #	DESCRIPTION
AW48228	Concave blades, 10-1/2" (26.5 cm)
AW48226	Flat blades, 10-3/4" (27.5 cm)

SCOVILLE BLADES

Solid.



CODE #	DESCRIPTION
AW55451	1" wide x 2-1/2" deep (25 mm x 64 mm)
AW55452	2" wide x 2-1/2" deep (51 mm x 64 mm)
AW55453	1-1/8" wide x 2-5/8" deep (29 mm x 67 mm)
AW55454	1" wide x 3-1/2" deep (25 mm x 89 mm)

SCOVILLE-HAVERFIELD RETRACTOR BLADE

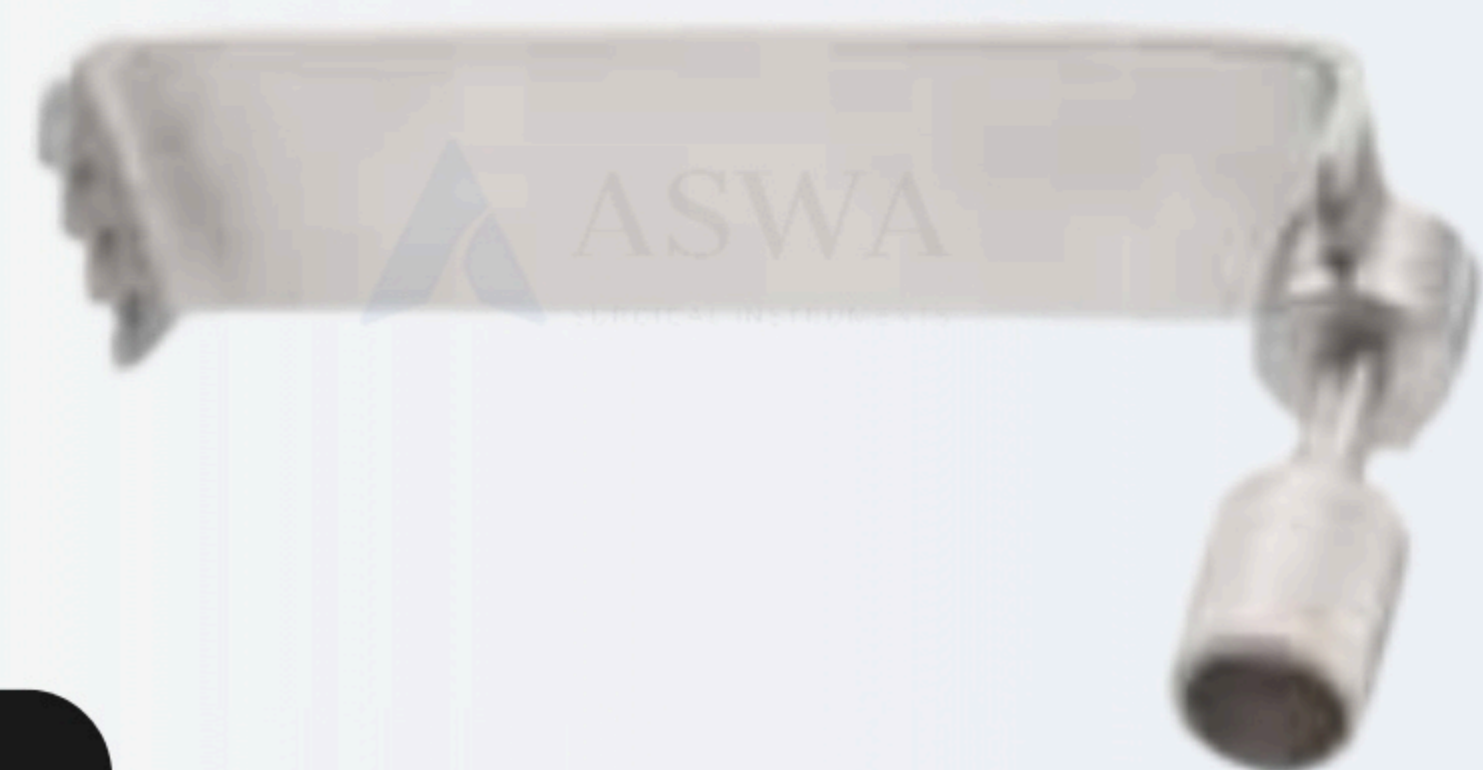

CODE #	DESCRIPTION
AW55455	1" x 3-1/2"

MEYERDING BLADES



CODE #	DESCRIPTION
AW55458	1" wide x 2 1/4" deep (25 x 57 mm)
AW55459	1" wide x 3" deep (25 x 76 mm)
AW55460	2" wide x 3-1/4" deep (51 x 83 mm)

SCOVILLE HEMILAMINECTOMY RETRACTOR BODY



CODE #	DESCRIPTION
AW55445	Spread 6-3/4" (17 cm), arm length 5-1/2" (14 cm)

HAVERFIELD-SCOVILLE HEMILAMINECTOMY RETRACTOR BODY

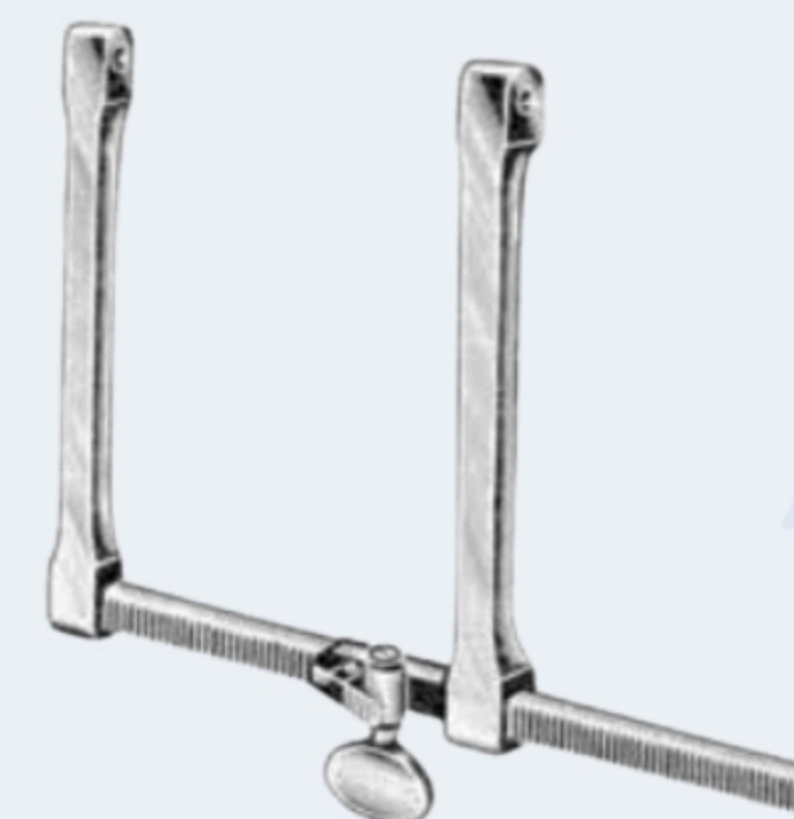

CODE #	DESCRIPTION
AW55446	Body only, 8-3/8" (21.5 cm)

INITIAL INCISION (CHARNLEY) RETRACTOR

Used primarily for hip procedures

CODE #	DESCRIPTION
AW52704	4 sharp prongs, stainless steel, maximum retraction width 9-3/4" (24.5 cm), prong depth 1-1/4" (32 mm), blade width 1" (25 mm), weight 3 lbs. Other blades are available
AW52704F	Frame only
AW52704S	S Short blade, 1-1/4" deep x 1" wide (34 x 25 mm)
AW52705S	Short blade, 2" deep x 1" wide (51 x 25 mm)
AW52706S	Short blade, 2-1/4" deep x 1" wide (57 x 25 mm)
AW52707S	Short blade, 2-1/2" deep x 1" wide (64 x 25 mm)
AW52708S	Short blade, 3" deep x 1" wide (77 x 25 mm)
AW52709S	Short blade, 4" deep x 1" wide (102 x 25 mm)
AW52711S	Short blade, 5" deep x 1" wide (127 x 25 mm)
AW52704L	Long blade, 1-1/4" deep x 1" wide (34 x 25 mm)
AW52705L	Long blade, 2" deep x 1" wide (51 x 25 mm)
AW52706L	Long blade, 2-1/4" deep x 1" wide (57 x 25 mm)
AW52707L	Long blade, 2-1/2" deep x 1" wide (64 x 25 mm)
AW52708L	Long blade, 3" deep x 1" wide (77 x 25 mm)
AW52709L	Long blade, 4" deep x 1" wide (102 x 25 mm)
AW52711L	Long blade, 5" deep x 1" wide (127 x 25 mm)



(CHARNLEY) RETRACTOR SET

HIBBS BLADES



CODE #	DESCRIPTION
AW55461	1" wide x 2" deep (25 x 51 mm)
AW55463	1" wide x 2-1/2" deep (25 x 64 mm)
AW55465	1" wide x 3" deep (25 x 76 mm)
AW55468	1" wide x 4" deep (25 x 102 mm)
AW55464	1-1/2" wide x 2-1/2" deep (38 x 64 mm)
AW55466	1-1/2" wide x 3" deep (38 x 76 mm)
AW55462	2" wide x 2" deep (51 x 51 mm)
AW55467	2" wide x 3" deep (51 x 76 mm)
AW55469	2" wide x 4" deep (51 x 102 mm)

SCOVILLE BLADES

4-prong



CODE #	DESCRIPTION
AW55456	1-1/2" wide x 1-5/8" deep (38 x 41 mm)
AW55457	1-7/8" wide x 2-5/8" deep (48 x 67 mm)

TAYLOR SPINAL BLADES

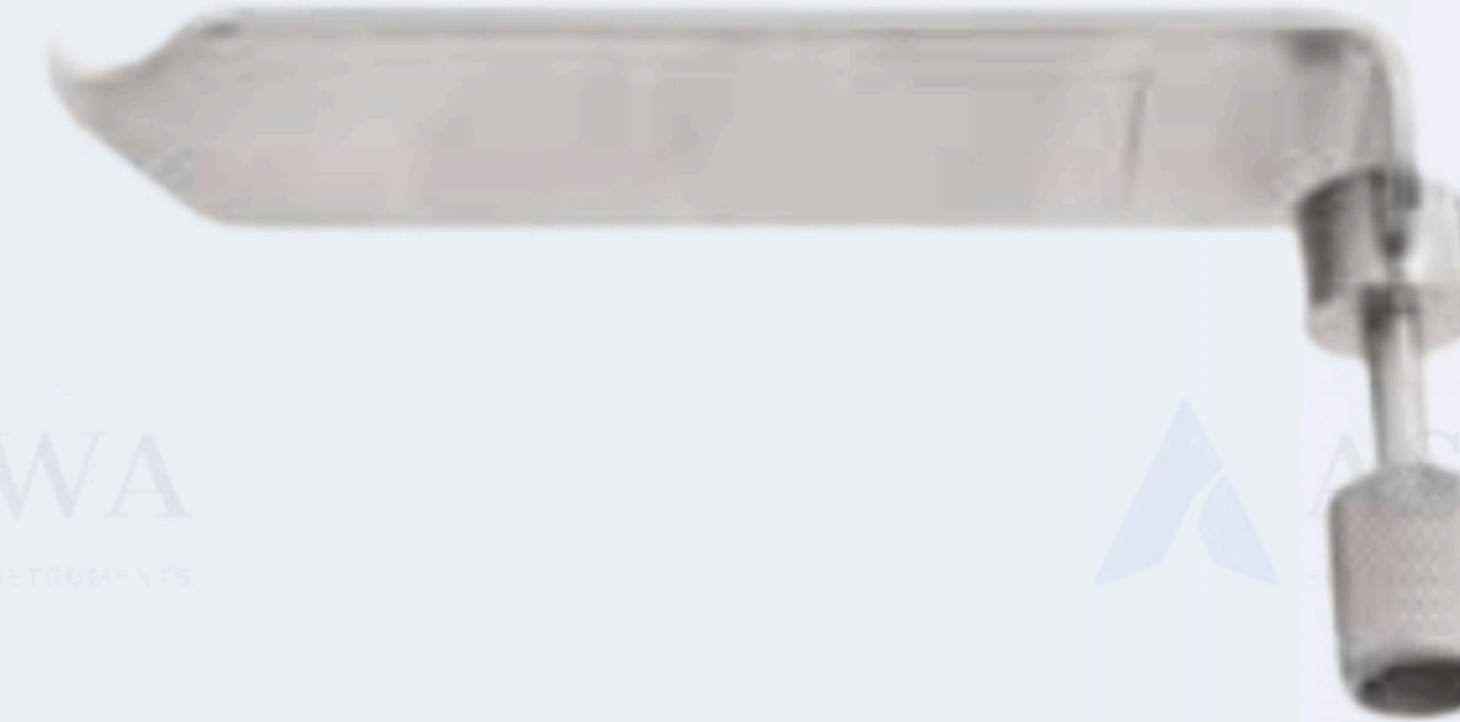

CODE #	DESCRIPTION
AW55471	1-1/4" wide x 3" deep (32 x 76 mm)
AW55472	1-1/4" wide x 4" deep (32 x 102 mm)

TAYLOR LAMINECTOMY BLADE



CODE #	DESCRIPTION
AW55473	3 prongs, 1-1/2" wide x 1-3/4" deep (38 x 44 mm)

TAYLOR LAMINECTOMY BLADES

4-prong



CODE #	DESCRIPTION
AW55474	2" wide x 1-7/8" deep (51 x 48 mm)
AW55476	2-1/4" wide x 3-1/8" deep (57 x 79 mm)
AW55475	2-1/2" wide x 2-1/2" deep (64 x 64 mm)

SCOVILLE BLADES

Hook style.



CODE #	DESCRIPTION
AW55447	2" deep (51 mm)
AW55448	3" deep (76 mm)
AW55449	2" deep (51 mm) with cross bar
AW55450	2-3/4" deep (70 mm) with cross bar

FRAZIER LAMINECTOMY RETRACTOR



CODE #	DESCRIPTION
AW52702	3 x 4 blunt prongs, spread 3-1/2" (9 cm), arm length 5" (12.5 cm)

CRUTCHFIELD TONGS

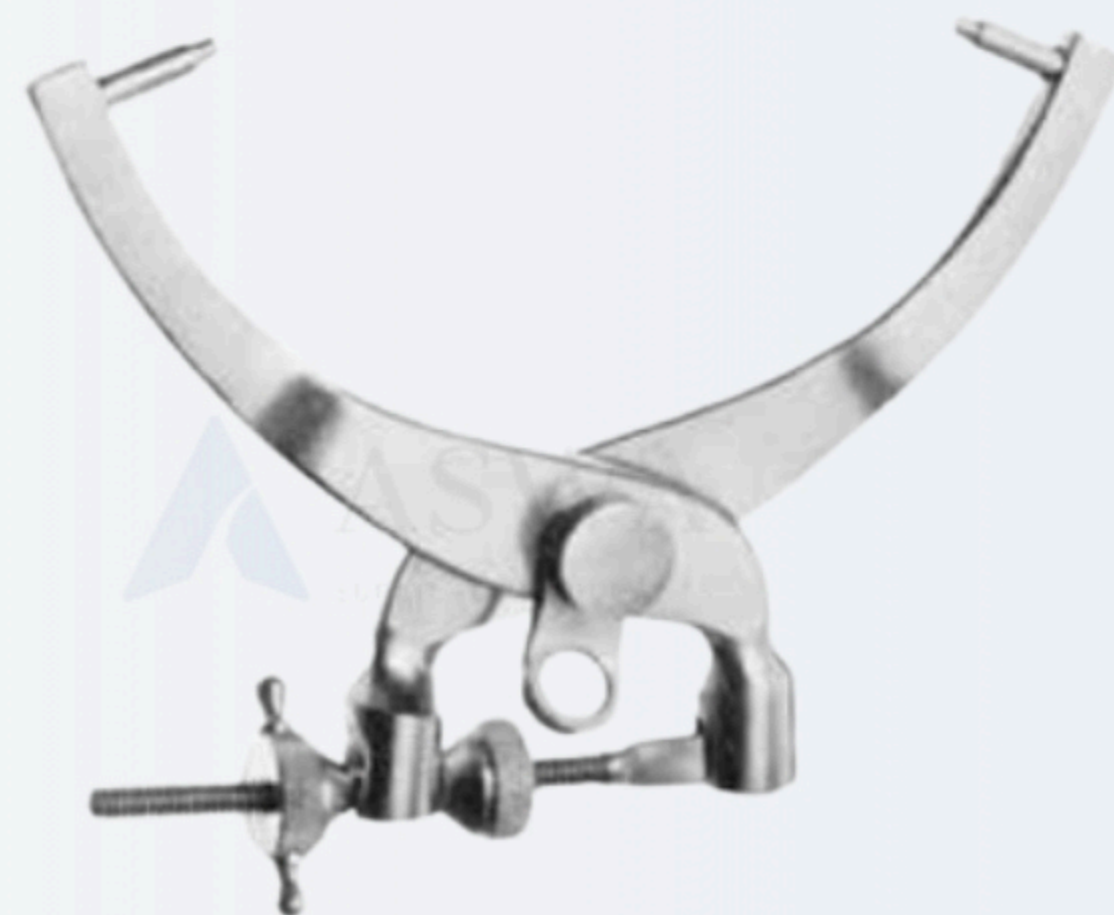

CODE #	DESCRIPTION
AW48249	With two drills, 4-7/8" (12.5 cm)